

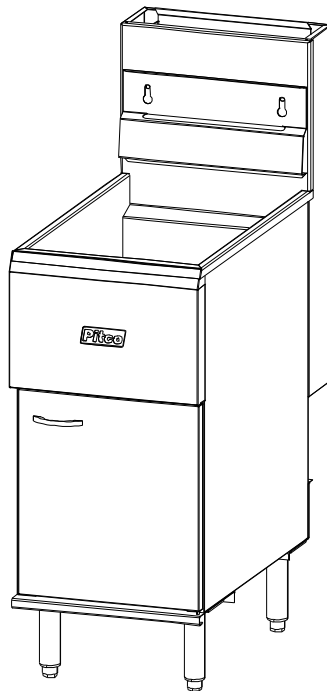

Installation, Operation, and Maintenance Manual  
For Gas Fryers

Covering Models  
45C+, 35C+ and 40C+, 65



ENGLISH

FRANCAIS



## NOTICES

There are three different types of notices that you should be familiar with, a NOTICE, CAUTION, and WARNING. A NOTICE is a special note used to call attention to a particularly important point. CAUTION is used to point out a procedure or operation which may cause equipment damage. The WARNING notice is the most important of the three because it warns of an operation that may cause personal injury. Please familiarize yourself with your new cooker before operating it and heed the notices throughout this manual. The WARNINGS are listed below and on the following page for your review prior to operating the unit.

### **FOR YOUR SAFETY**

**DO NOT store or use gasoline or other flammable vapors or liquids in the vicinity of this or any other appliance.**

**WARNING: Improper installation, adjustment, alteration, service or maintenance can cause property damage, injury or death. Read the installation, operating and maintenance instructions thoroughly before installing or servicing this equipment.**

### **TO THE PURCHASER**

**POST IN A PROMINENT LOCATION INSTRUCTIONS TO BE FOLLOWED IN THE EVENT THAT AN OPERATOR SMELLS GAS. OBTAIN THIS INFORMATION FROM YOUR LOCAL GAS SUPPLIER.**

**THIS MANUAL MUST BE RETAINED FOR FUTURE REFERENCE**

**SAFETY**

**SAFETY**

**SAFETY**

**SAFETY**

**SAFETY**

**WARNING**

The cooker must be electrically grounded in accordance with local codes. If local codes do not apply, follow the requirements of National Code ANSI/NFPA 70-1990.

**WARNING**

This cooker is equipped with a three prong safety plug. This safety plug protects operators from electrical shock in the event of an equipment malfunction. **DO NOT** remove the grounding (third) prong from this plug.

**WARNING**

**DO NOT** use an open flame to check for gas leaks!

**WARNING**

A cooker that is equipped with casters and a flexible power cord must be connected to the gas supply with a Quick-Disconnect device. This quick disconnect must comply with ANSI Z24.41-1989. A restraining cable must be installed to limit the movement of the cooker.

**WARNING**

There is an open gas flame inside the cooker. The unit may get hot enough to set nearby materials on fire. Keep the area around the cooker free from combustible materials.

**WARNING**

Ensure that the cooker can get enough air to keep the flame burning correctly. If the flame is starved for air it can give off dangerous carbon monoxide. Carbon Monoxide is a clear odorless gas that can cause suffocation and death.

**WARNING**

Be sure the burner tubes are **COMPLETELY** covered with water before lighting the pilot or main burners. If the tubes are exposed, the cooker may overheat, causing damage to the kettle, creating a fire hazard, and voiding the warranty.

**SAFETY**

**SAFETY**

**SAFETY**

**SAFETY**

**SAFETY**

**SAFETY**

**SAFETY**

**SAFETY**

**SAFETY**

**SAFETY**

**WARNING**

Carbon monoxide can build up if the flue is blocked. Blocking the flue will also cause the cooker to overheat. Ensure that minimum clearances specified in the installation instructions are maintained. **DO NOT** obstruct the flow of combustion/ventilation or air opening around the Noodle Cooker. Adequate clearance around the cooker is necessary for servicing and proper burner operation. Ensure that you meet the minimum clearances specified in the installation instructions.

**WARNING**

The power supply must be disconnected before servicing or cleaning the appliance.

**WARNING**

For gas cookers, **DO NOT** supply the cooker with a gas that is not listed on the data plate. If you need to convert the cooker to another type of fuel, contact your dealer.

**WARNING**

For gas cookers, **WAIT** five (5) minutes before attempting to relight the pilot. This allows time for any gas remaining in the cooker to dissipate.

**ENGLISH**

**THIS MANUAL MUST BE RETAINED FOR FUTURE REFERENCE**

**SAFETY**

**SAFETY**

**SAFETY**

**SAFETY**

**SAFETY**



# Table of Contents

Section	Title	Page
	Table of Contents .....	i
	List of Tables and Figures .....	ii
<b>Chapter 1: General Information and Installation .....</b>		<b>1-1</b>
1.1	WHICH FRYER DO I HAVE? .....	1-1
1.2	CHECKING YOUR NEW FRYER .....	1-1
1.2.1	Check Your Order .....	1-2
1.3	ASSEMBLY AND LEVELING .....	1-2
1.3.1	Leg/Caster Installation and Adjustment .....	1-2
1.3.2	Assembling Multi Fryer Systems .....	1-3
1.4	INSTALLATION .....	1-3
1.4.1	Installation Clearances .....	1-3
1.4.2	Gas Connection .....	1-3
1.4.2.1	Fuel Types .....	1-4
1.4.2.2	Gas Line Connection .....	1-4
1.4.2.3	Quick Disconnect Gas Connection .....	1-4
1.4.2.4	Fuel Supply Line Leak and Pressure Testing .....	1-5
1.4.3	Ventilation and Fire Safety Systems .....	1-5
1.5	INITIAL ADJUSTMENTS .....	1-5
1.5.1	Visual Checks .....	1-6
1.5.2	Burner Ignition Systems .....	1-6
1.5.2.1	Pilot Flame Adjustment .....	1-7
1.5.3	Main Burner System .....	1-8
1.5.3.1	Gas Line Requirements .....	1-8
1.5.3.2	Burner Adjustment .....	1-8
1.5.4	Initial Cleaning .....	1-9
1.5.5	Thermostat Calibration Check .....	1-10
1.5.6	Thermostat Calibration .....	1-11
<b>Chapter 2: Operating Instructions .....</b>		<b>2-1</b>
2.1	FILLING THE FRYER .....	2-1
2.1.1	Filling the Fryer With Liquid Shortening .....	2-1
2.1.2	Filling the Fryer With Solid Shortening .....	2-1
2.2	OPERATING INSTRUCTIONS .....	2-2
2.2.1	Fryer Start-Up .....	2-2
2.2.2	Melting Solid Shortening .....	2-2
2.2.3	Fryer Shutdown .....	2-3
2.3	DAILY CLEANING .....	2-3
<b>Chapter 3: Owner Maintenance and Adjustments .....</b>		<b>3-1</b>
3.1	WEEKLY FRYER CLEANING (BOIL OUT) .....	3-1
3.2	FLUE INSPECTION .....	3-1
3.3	TROUBLESHOOTING .....	3-2

# List of Tables and Figures

<b>Table</b>	<b>Title</b>	<b>Page</b>
1-1	Fryer Model Information .....	1-1
1-2	Ventilation and Fire Safety References .....	1-7

<b>Figure</b>	<b>Title</b>	<b>Page</b>
1-1	Pilot Assembly, Flame Adjustment .....	1-8
1-2	Gas Valve Showing Location of Pressure Regulator and Pilot Adjusters .....	1-9



## Chapter 1: General Information and Installation

Congratulations on the purchase of your new Pitco Frialator universal fryer. This unit will give you many years of reliable service if you follow the simple operation and maintenance procedures in this manual. Contained in this manual are the general installation, operation, and maintenance procedures for the universal fryer Models 45C+, 35C+ 40C+, and 65C+.

### 1.1 WHICH FRYER DO I HAVE?

There are two models of this gas fryer available. Each fryer has its own model number. To find out which model you have, look inside the door at the equipment identification plate. This plate has a lot of useful information, but to identify which fryer you have, look at the model number block. The model number identifies which fryer you have. A brief description of each model is provided in Table 1-1.

Table 1-1 Fryer Model Information

Model Number	Description	Features
45C+	This fryer can cook up to 85 lbs. of potatoes per hour.	Frying Area: 14" x 14" Oil Capacity: 42 lbs. BTU Input: 122,000
35C+	This fryer can cook up to 63 lbs. of potatoes per hour.	Frying Area: 14" x 14" Oil Capacity: 35 lbs. BTU Input: 90,000
40C+	This fryer can cook up to 72 lbs. of potatoes per hour.	Frying Area: 14" x 14" Oil Capacity: 45 lbs. BTU Input: 105,000
65C+	This fryer can cook up to 120 lbs. of potatoes per hour.	Frying Area: 18" x 18" Oil Capacity: 65 lbs. BTU Input: 150,000

### 1.2 CHECKING YOUR NEW FRYER

Your new fryer has been carefully packed into one crate. Every effort has been made to ensure that your fryer is delivered to you in perfect condition. As you unpack your new fryer, inspect each of the pieces for damage. If something is damaged, DO NOT sign the bill of lading. Contact the shipper immediately, the shipper is only responsible for 15 days after delivery. Check the packing list enclosed with your fryer to ensure that you have received all of the parts to the fryer. If you are missing any parts, contact the dealer from whom the fryer was purchased. As you unpack the fryer and it's accessories be careful to keep the weight of the fryer evenly distributed.

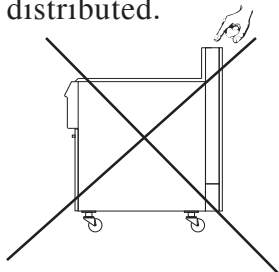

#### CAUTION

To prevent equipment damage, don't tilt the fryer onto any two of it's casters or pull the unit by the flue vents.

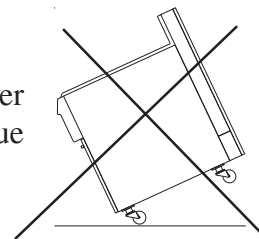

Locate your Pitco Frialator warranty and fill in the serial number of the fryer and the date received. You will find the serial number on the plate inside the door. Put your warranty card in a safe place for future reference. DO NOT return the card to Pitco Frialator.

### 1.2.1 Check Your Order

The crate containing the fryer unit will also contain the following:

- (2) Pitco Cleaner Sample
- (1) Drain Clean Out Rod

## 1.3 ASSEMBLY AND LEVELING

When you receive your fryer, it is completely assembled with the possible exception of the legs (or casters) and the heat shield. In some cases, if you have purchased a multi-fryer unit, you may need to assemble the system.

### 1.3.1 Leg/Caster Installation and Adjustment

Installing the legs and leveling the fryer is done with a 7/16" wrench, socket, and a large pair of water pump pliers. The legs/casters must be installed to provide the necessary height to meet sanitation requirements and assure adequate air supply to the burner. Attach the legs by performing the following procedure.

- a. Lay the fryer on its side being careful not to damage the flue by pulling on it. Protect the outside of the fryer with cardboard or a drop cloth when laying it down.
- b. Attach each leg/caster with the hex head cap screws supplied with the fryer. Each leg/caster requires four 1/4-20 x 5/8" cap screws.
- c. Mount the screws from the inside of the fryer with the nut on the outside. The nuts have lock washers attached to them, therefore it is not necessary to use lock washers.
- d. When all four legs/casters are mounted, stand the unit up being careful not to put too much weight on any one leg/caster. Adjust the height and level the fryer by adjusting the leveling devices on the leg/caster with the water pump pliers.
- e. On units with casters, move the fryer to the desired location and lock the wheels using the locking devices on the sides of the casters.

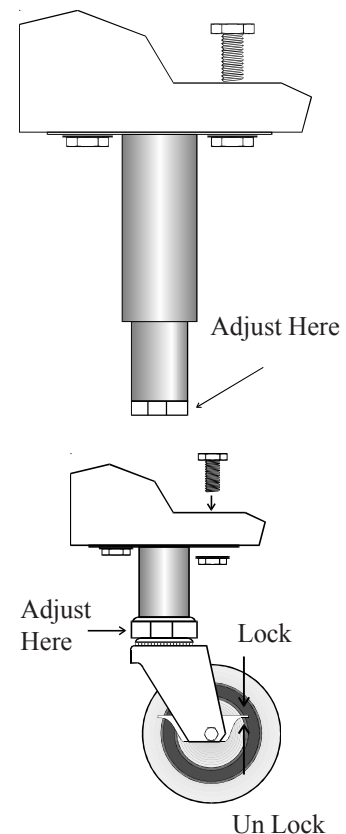

### 1.3.2 Assembling Multi Fryer Systems

If you purchased a multi-fryer unit, it could be shipped in more than one piece. To assemble the unit follow the instructions below.

- a. Unpack the units and move them close together. Remove the front panels and both heat shields from the fryers.
- b. There are five joining strips to be attached to the units to make them into one system. These strips are attached in the rear, front, upper front, and the forward and rear caster mount. Use the screws supplied with your system to attach the strips. Secure them tightly to each unit.
- c. Replace the heat shield and front panels to complete the system assembly.

## 1.4 INSTALLATION

Although it is possible for you to install and set up your new fryer, it is **STRONGLY** recommended that you have it done by qualified professionals. The professionals that install your new fryer will know the local building codes and ensure that your installation is safe.

### WARNING

The fryer must be properly restrained to prevent movement or tipping. This restraint must prevent the fryer from movements that would splash hot liquids on personnel. This restraint may be any means (alcove installation, adequate ties, or battery installation).

### 1.4.1 Installation Clearances

The fryer needs clearance around it for proper operation. Adequate clearances allow for servicing and proper burner operation. The clearances shown below are for cooker installation in combustible and non-combustible construction.

	Combustible Construction	Non-Combustible Construction
Back	6"	0"
Sides	6"	0"
Floor - Combustible	6"	6"

### 1.4.2 Gas Connection

Your fryer will give you peak performance when the gas supply line is of sufficient size to provide the correct gas flow. The gas line must be installed to meet the local building codes or National

Fuel Gas Code (NFPA 54-Latest Edition) and ANSI Z223.1-Latest Edition Latest Edition. In Canada, install the fryer in accordance with CAN/CGA-B149.1 or .2 and local codes. Gas line sizing requirements can be determined by your local gas company by referring to National Fuel Gas Code, Appendix C, Table C-4 (natural gas) and Table C-16 (propane). The gas line needs to be large enough to supply the necessary amount of fuel to all appliances without losing pressure to any appliance. Other factors that are used to determine the piping requirements are BTU requirements of the appliances being connected and the length of pipe between the meter (main shut off) and the appliances.

### **WARNING**

NEVER supply the fryer with a gas that is not indicated on the data plate. Using the incorrect gas type will cause improper operation. If you need to convert the fryer to another type of fuel, contact your dealer.

1.4.2.1 Fuel Types - Each fryer is equipped to work with one type of fuel. The type of fuel with which the appliance is intended to operate is stamped on the data plate attached to the inside of the door.

### **WARNING**

DO NOT use an open flame to check for gas leaks!

1.4.2.2 Gas Line Connection - Connect the fryer to the gas supply line with a connector that complies with the Standard for Connectors for Movable Gas Appliances (ANSI Z21.69-Latest Edition). If you are installing a fryer with casters use a quick disconnect refer to the Quick Disconnect installation instruction, 1.4.2.3. Connect the gas line to the fryer using a pipe joint sealant that is resistant to liquefied petroleum. If the fryer was disconnected during the fuel line testing, use a solution of soap and water to leak test the new connection.

### **NOTICE**

NEVER use an adaptor to make a smaller gas supply line fit the cooker connection. This may not allow proper gas flow for optimum burner operation, resulting in poor cooker performance.

1.4.2.3 Quick Disconnect Gas Connection - Gas fryers equipped with casters must be installed with connectors that comply with the Standard for Connectors for Movable Gas Appliances, ANSI Z21.69-Latest Edition, and Addenda Z21.69A-Latest Edition. This connection should include a quick disconnect device that complies with the Standard for Quick Disconnect Devices for Use With Gas Fuel, ANSI Z21.41-Latest Edition. When installing a quick disconnect you must also install a means for limiting the movement of the fryer. This device will prevent the gas line or the quick disconnect from being strained. The restraining device should be attached to the cooker on the back panel as shown in the illustration. The quick disconnect, hose, and restraining device can be obtained from your dealer.

**1.4.2.4 Fuel Supply Line Leak and Pressure Testing** - The fuel supply system must be tested before the fryer is used. If the fuel line is going to be tested at a pressure greater than ( $>$ ) 1/2 PSIG (3.45 kPa), make sure that the fryer is disconnected from the fuel line. If the fuel line is to be tested at a pressure equal to or less than ( $\leq$ ) 1/2 PSIG (3.45 kPa), the fryer can be connected but the unit's gas valve must be shut. Test all gas line connections for leaks with a solution of soap and water when pressure is applied.

### **1.4.3 Ventilation and Fire Safety Systems**

Your new fryer must have proper ventilation to function safely and properly. Exhaust gas temperatures can reach as high as 1200°F. Therefore, it is very important to install a fire safety system. Your ventilation system should be designed to allow for easy cleaning. Frequent cleaning of the ventilation system and the fryer will reduce the chances of fire. Table 1-2 provides a list of reference documents that provide guidance on ventilation and fire safety systems. This table is not necessarily complete. Additional information can be obtained from the American Gas Association, 8501 East Pleasant Valley Road, Cleveland, OH 44131.

Excessive ventilation causes drafts, which will interfere with the proper operation of the pilot and the burner. Leave at least 18 inches of open space between the fryer's flue vent opening and the intake of the exhaust hood.

#### **CAUTION**

Ensure that your ventilation system does not cause a down draft at the fryer's flue opening. Down drafts will not allow the fryer to exhaust properly and will cause overheating which may cause permanent damage. Damage caused by down drafts will not be covered under equipment warranty. NEVER allow anything to obstruct the flow of combustibles or ventilation exiting from the fryer flue. DO NOT put anything on top of the flue area.

#### **NOTICE**

NEVER connect the blower directly to the flue openings. The direct flow of air will cause poor temperature recovery, poor ignition, inefficient operation of the fryer, and could extinguish the pilot.

## **1.5 INITIAL ADJUSTMENTS**

After your fryer has been installed as described in section 1.4, it needs to be adjusted to ensure that it will perform as designed. These adjustments must be performed by a **qualified person**. To perform these adjustment the following tools will be needed:

- Manometer (low pressure gauge)
- Digital Thermometer (Temperature probe)
- DC Millivolt Meter

### 1.5.1 Visual Checks

After the fryer is in its permanent location, lock the casters and check for levelness. Any additional leveling that is necessary can be performed as described in section 1.3.

### 1.5.2 Burner Ignition Systems

#### CAUTION

Before going any further, fill the fryer with WATER. Water is used for the installation adjustments because the temperature will never exceed 212°F (100°C) thereby allowing plenty of adjustment time. Never let the water level go below the MIN LEVEL mark on the rear of the tank.

#### WARNING

There is an open flame inside the fryer. The unit may get hot enough to set near by materials on fire. Keep the area around the fryer free from combus-

Table 1-2. Ventilation and Fire Safety References

Topic	Underwriters Laboratory Document	National Fuel Gas Code Document
Grease Extractor	ANSI/UL 710-Latest Edition	ANSI/NFPA 96-Latest Edition
Ventilation Hood	ANSI/UL 705-Latest Edition	ANSI/NFPA 96-Latest Edition
Type of Fire Extinguishers and Detection Equipment		
CO <sub>2</sub>	ANSI/UL 154-Latest Edition	ANSI/NFPA 12-Latest Edition
Dry Chemical	ANSI/UL 299-Latest Edition	ANSI/NFPA 17-Latest Edition
Water	ANSI/UL 626-Latest Edition	ANSI/NFPA 13-Latest Edition
Foam		ANSI/NFPA 11-Latest Edition
Sprinklers	ANSI/UL 199-Latest Edition	ANSI/NFPA 13-Latest Edition
Smoke Detectors	ANSI/UL 268-Latest Edition	ANSI/FPA 72B-Latest Edition
Fire Detection Thermostats	ANSI/UL 521-Latest Edition	ANSI/FPA 72B-Latest Edition

tibles.

To light the pilot light, refer to these instructions.

### WARNING

Wait 5 minutes before attempting to relight the pilot to allow for any gas in the fryer to dissipate.

- a. Open the gas supply valves to the fryer.
- b. Open the fryer's door to gain access to the controls. Turn the thermostat control knob counterclockwise to the OFF position.
- c. Turn the Unitrol valve knob to the PILOT position and push in on the knob. Hold the knob in for approximately one minute to purge the air out of the line. Hold a flame to the pilot light until the pilot ignites. This may take a little while the first time you light the fryer because of air in the lines. Once lit, hold the knob in for approximately 60 seconds and then release.
- d. If the pilot goes out wait 5 minutes and repeat step c. If after three tries the pilot will not remain lit, refer to the operator troubleshooting section of this manual.
- e. Turn the Unitrol valve knob counterclockwise to the ON position.
- f. Set the thermostat control knob to the desired temperature setting.
- g. The main burner will light and be controlled by the thermostat.
- h. To completely shut down the fryer, turn the Unitrol valve knob to pilot, push in and continue turning to OFF.

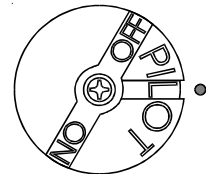

1.5.2.1 Pilot Flame Adjustment - The pilot flame should be adjusted to produce the proper millivolt output from the pilot sensing device. Millivolt output for the thermopile should be between 300 and 500 millivolts. This procedure is only necessary on the manual pilot ignition system. Figure 1-1 shows the pilot assembly with examples of the incorrect and correct pilot size. Example A illustrates a pilot flame size that is too small to produce sufficient millivolt output. Example B is the correct size for proper millivolt output.

- a. This test requires a DC millivolt meter set to a scale of 0-1000mv.

- b. Locate the thermopile wires coming from the thermostat/High Limit box going to the gas shut off valve. The wire insulation size decreases near the gas valve connections.
- c. Connect the negative (-) test probe to pilot bracket.
- d. Connect the positive (+) test probe to to one of the High Limit terminal connections
- e. Remove the pilot flame adjustment cover.
- f. Turning the flame adjusting screw clockwise lowers the flame and the millivolt output. Turning the screw counterclockwise increases flame size and millivolt output.
- g. Rotate the screw in the direction to achieve a reading of  $400 \pm 50$  mv for thermopiles.

### NOTICE

Allow 3 to 5 minutes between flame adjustments to allow the reading to settle.

- h. Replace the pilot flame adjusting screw cover.

### 1.5.3 Main Burner System

For the burners to work, the gas supply valve must be open. The main burner receives gas from the main gas supply through the thermostatically controlled valve. When the thermostat is turned up the gas control valve opens. The pilot ignites the burners. The burner flame should be adjusted at the air collar (at the bottom of the burner) so the the flame are a soft blue color without lifting off the face of the burner.

- 1.5.3.1 Gas Line Requirements - A properly installed gas supply system will deliver  $7.0 \pm 2.0$ " w.c.

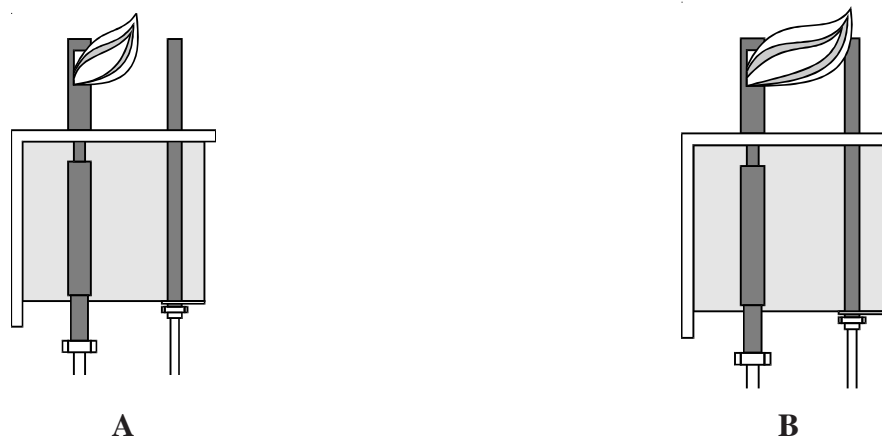

Figure 1-1 Pilot Assembly, Flame Adjustment



natural gas (12.0 ±2.0" w.c. LP) to all appliances connected to the line, operating at full demand.

1.5.3.2 Burner Adjustment - The burners must be adjusted to deliver optimum flame. Adjust the burner flame using the following procedure.

- a. Ensure that the Unitrol valve knob is in the OFF position. Remove the manifold pressure tap plug and connect an accurate pressure gauge (range of 0-16" w.c. in 0.1" increments) or manometer.
- b. Light the pilot burner (see 1.5.2) for the unit being tested and adjust the thermostat to light the main burners.
- c. The installed pressure gauge reading should be the same, ±0.1", as that marked on the data plate inside the door. If the pressure is correct go to step e, if not, adjust the pressure.
- d. To adjust the pressure, remove the regulator adjustment screw cover (see Figure 1-3). Use a flat tip screwdriver to adjust the screw until the proper pressure is reached. Turning the screw clockwise will increase the pressure, counterclockwise will decrease the pressure.
- e. When the pressure is correct, install the regulator adjustment screw cover.
- f. To remove the pressure gauge, turn gas control valve to OFF. Remove the gauge and install the pressure tap plug.
- g. Now that the pressure is set for proper operation, set the main burner flame. Unlock the air collars by loosening the set screw for the collars. See Figure 5. Turn the Unitrol valve knob to ON and turn thermostat to light the main burners.
- h. Adjust the shape and size by raising or lowering the air collars to achieve a soft blue flame with well defined inner cones.
- i. When the flames have been properly adjusted, lock the collars in place with the set screw provided.

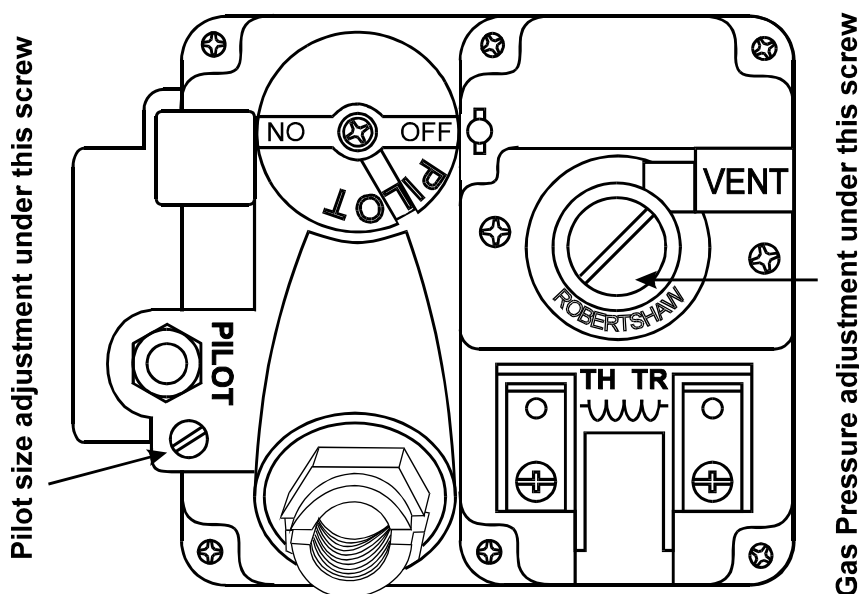

Figure 1-2 Gas Valve Showing Location of the Pressure Regulator and Pilot Adjusters

### **1.5.4 Initial Cleaning**

When the fryer is shipped, many of its parts are covered with a thin coat of oil for protection. Before the fryer is ready for cooking it must be cleaned. This will remove the oil coating and any foreign matter that may have accumulated during storage and shipment. Perform the cleaning as described below.

- a. Fill the tank with water and add one packet of Pitco fryer cleaner or a mild detergent.
- b. Turn the fryer on and set the thermostat to 200°F. Allow the fryer to heat for 15 minutes.

#### **NOTICE**

Do not leave the fryer unattended during cleaning. Never let the water level go below the "Min Level" mark on the back of the tank.

- c. Using the fryer cleaning brush, scrub the inside of the fryer to remove protective coating.
- d. When cleaning is complete, turn off the fryer main burners and turn the Unitrol valve knob to the PILOT position. Drain the water into a container suitable for hot water and dispose of it.
- e. When the tank has cooled, rinse it thoroughly with cool water. Continue to rinse the tank until the cleaner has been rinsed, thoroughly from the tank.
- f. Using a clean dry cloth, wipe out all of the water. Be very thorough removing the water, because any residual water will cause hot oil to splatter out of the fryer.

#### **CAUTION**

Mild steel tanks must be wiped down/coated with oil to keep the tank from rusting.

- g. Now that the tank is clean, you are ready to fill and operate the fryer. Refer to 2.1 for instructions on adding shortening to the fryer.

### **1.5.5 Thermostat Calibration Check**

#### **NOTICE**

Thermostat calibration requires that the temperature of the fryer be raised above boiling. Therefore, you will need to drain the water from the fryer and fill it with oil. Before removing the water, perform the initial cleaning of the fryer. Cleaning the fryer now will prevent you from having to drain the oil and refill

with water later.

Filling the fryer with oil is described in 2.1. To perform the calibration check detailed below you will need a digital thermometer.

- a. Place the tip of the thermometer in the shortening approximately 1" above the temperature sensors.
- b. Set the thermostat at 325°F and wait for the temperature reading on the thermometer to rise. As the temperature rises toward 325°F watch the thermometer closely.
- c. If the shortening temperature reaches 350°F and the burners DO NOT turn off, turn the thermostat down. Keep lowering the thermostat setting until the burners go out.

### CAUTION

If the burners do not turn off at the lowest thermostat setting, the thermostat could be defective. Contact your representative immediately.

- d. Let the fryer cycle 4 to 6 times before checking the temperature. Compare the thermometer temperature against the thermostat setting. If the values are more than 5°F apart, calibrate the thermostat using the appropriate calibration procedure in this manual.

#### 1.5.6 Thermostat Calibration

- a. Place the tip of the thermometer in the shortening approximately 1" above the temperature sensors.
- b. Set the Thermostat to 325°F and wait for the temperature reading on the thermometer to rise.
- c. Let the fryer cycle 4 to 6 times to ensure that the temperature has stabilized. Compare the thermometer temperature against the thermostat setting. If the values are more than 5°F apart, calibrate the thermostat using the appropriate calibration procedure.



## Chapter 2: Operating Instructions

This chapter describes how to operate your fryer to obtain the best performance. Included in this chapter are filling, operating, and cleaning instructions for gas fryers.

### 2.1 FILLING THE FRYER

Both liquid and solid shortening can be used in the fryer, but liquid is preferred. To melt solid shortening, carefully follow the instruction in section 2.2.2.

#### 2.1.1 Filling the Fryer With Liquid Shortening

- Make sure the drain valve is completely closed.
- Fill the fryer with oil to the "Oil Level" line marked on the back of the tank.

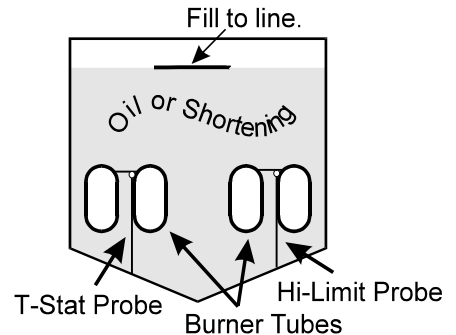

#### 2.1.2 Filling the Fryer With Solid Shortening

### WARNING

Never melt blocks of solid shortening on top of the burner tubes. This will cause a fire and will void your warranty.

- Make sure the drain valve is completely closed.
- Remove the screen covering the tubes.
- Cut the shortening into cubes no larger than 1". ALWAYS pack the shortening below, between, and on top of the burner tubes. DO NOT leave any large air gaps. Use care when packing the solid shortening in the tank. DO NOT bend or break the temperature sensor probes. If these are damaged the fryer will not function properly.

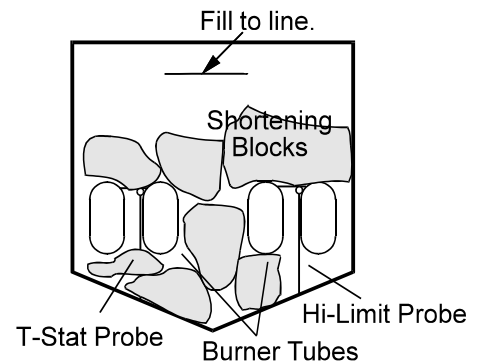

- Once the fryer is packed with shortening, the shortening must be melted. To melt the shortening, refer to Fryer Start-Up, section 2.2.1, and Melting Solid Shortening, section 2.2.2.

## **2.2 OPERATING INSTRUCTIONS**

To ensure the food always comes out the very best, follow the preparation instructions for the food you are cooking. Using the best shortening makes the best fried foods. The best shortening will last longer than lower grade shortening and save you money. When not in use the shortening should be cooled and covered to prevent contamination.

### **CAUTION**

The fryer has been installed using restraining devices to prevent accidental tipping or movement. Do not attempt to move the fryer when it has hot liquid in it. Splashing hot liquids can cause severe burns.

### **WARNING**

Water and shortening **DO NOT** mix. Keep liquids away from hot shortening. Dropping liquid frozen food into the hot shortening will cause violent boiling.

#### **2.2.1 Fryer Start-Up**

##### **DO NOT START FRYER WITHOUT FILLING WITH OIL!**

- a. Light the pilot light as described in section 1.5.2.
- b. Turn the temperature control knob (thermostat) to the desired temperature setting. This knob is located behind the front doors or on the front control panel.
- c. The main burners will light.

#### **2.2.2 Melting Solid Shortening**

### **NOTICE**

The melting procedure below requires cycling of the fryer. Watch carefully for smoke. If smoke is noticed, the shortening is scorching. To prevent this, decrease the time you leave the burners on.

- a. Place the Unitrol valve in ON position.
- b. Set thermostat to 150°F.
- c. Allow main burners to fire for approximately four (4) seconds.
- d. Turn thermostat down until main burners go out.

- e. Wait 30 seconds.
- f. Repeat steps c. through e. until the shortening is melted.
- g. Set thermostat to normal operating temperature. The burners will remain on constantly until the shortening temperature reaches the thermostat setting.
- h. Once at temperature, the fryer is now operating normally and ready to use.

**2.2.3 Fryer Shut-Down**

There are two shutdown modes of fryer operation, STANDBY and COMPLETE. The standby mode removes the ability for the fryer's main burners to cycle. Complete shutdown turns off the gas supply to the fryer. Shut down the fryer by:

**STANDBY** Turn the thermostat to OFF. Turn the gas valve clockwise to the PILOT position. The cooker is now in Standby and can remain this way for only brief periods of time. NEVER leave the cooker in standby overnight.

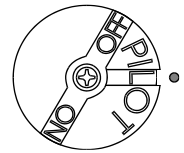

**COMPLETE** To completely shut down the cooker, push and turn the gas valve counterclockwise to the OFF position. The fryer is now completely shut down and can be cleaned and filtered.



**2.3 DAILY CLEANING**

Your fryer should be cleaned every day to maintain peak performance and appearance. Perform the procedures below every day.

- a. Wipe up any shortening that spills onto the exterior of the fryer. This should be done with a clean soft cloth while the oil is still warm.
- b. Use warm water with a mild detergent to clean surfaces. Be careful not to get water in the shortening and to remove any detergent from the fry tank.
- c. Use a non-abrasive scouring powder or pad to clean stains if necessary.
- d. Perform the weekly boil out cleaning of your fryer described in section 3.2.

## Chapter 3: Owner Maintenance and Adjustments

This chapter provides you with the information and procedures necessary to perform basic fryer maintenance and adjustments. If, after performing maintenance on your fryer, it does not perform properly, contact your authorized service center.

### 3.1 WEEKLY FRYER CLEANING (BOIL OUT)

The fryer should be thoroughly cleaned once a week. This cleaning should include a complete draining of the fryer and a boil out.

- a. You will need a container large enough to hold 1 1/2 times the oil in one tank. This container should also be able to withstand boiling water temperatures.

#### CAUTION

Completely shut down the fryer when the oil is to be replaced by water, and when the heating portion of the cleaning is complete. This will prevent the heating system from coming on during the oil draining and water filling procedure.

- b. Drain the oil from the fryer and discard or save for reuse. Remove tube rack/mesh tube screens and remove any large debris from the bottom of the fry tank. Once clean, return tube rack/mesh screens to the fry tank. Close the drain valve and fill the fry tank with water and noncaustic detergent. For best results, use Pitco Fryer Cleaner, part number P6071397.
- c. Restart your fryer as described in 2.3 and set the thermostat to 200°F and bring the water to a slow boil. **DONOT** allow water to boil because excessive foaming will occur. Once the water is at a slow boil turn off the fryer.
- d. Allow the fryer to soak for 20 minutes to soften shortening deposits and carbon. Use the fryer brush to remove any residue from tank, heating tubes, and side walls. Perform the daily cleaning procedure described in section 2.6.
- e. Wipe the tank dry with clean cloth wipes. Close the drain valve and remove the large container.
- f. Refer to section 2.1 to refill the fryer.

### 3.2 FLUE INSPECTION

It is recommended that once every six months, with the cooker cooled down, you examine the flue area. Check for corrosion or blockage of the flue. Ensure that the cooker is shutdown and do not turn it on during the examination. Examination of the flue area during cooking may cause bodily injury.



### 3.3 TROUBLESHOOTING

This section is provided to aid you in the event of fryer or filter troubles. If these troubleshooting procedures do not correct your problem contact a qualified technician or the factory. The troubleshooting procedures are in a flowchart format.

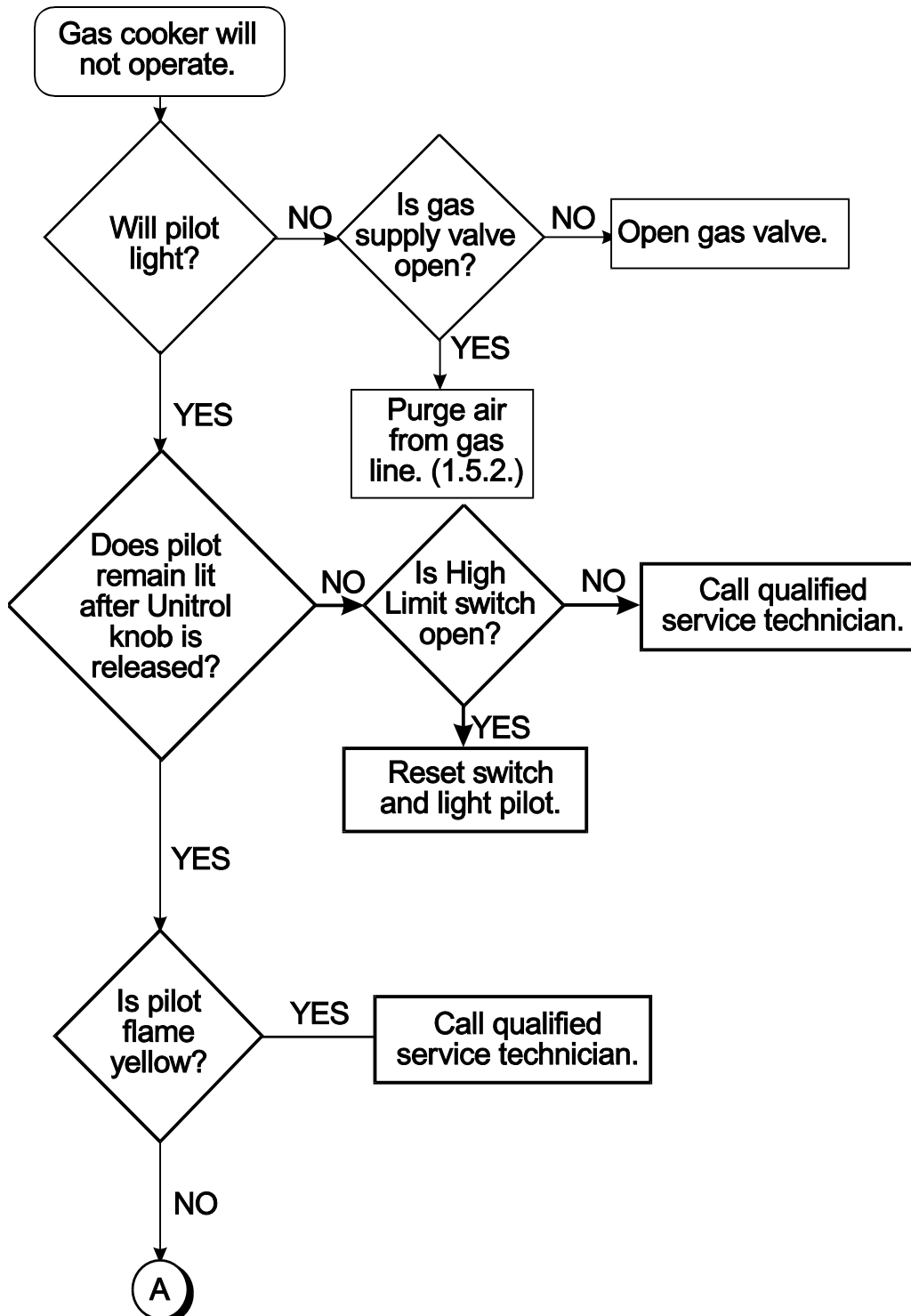

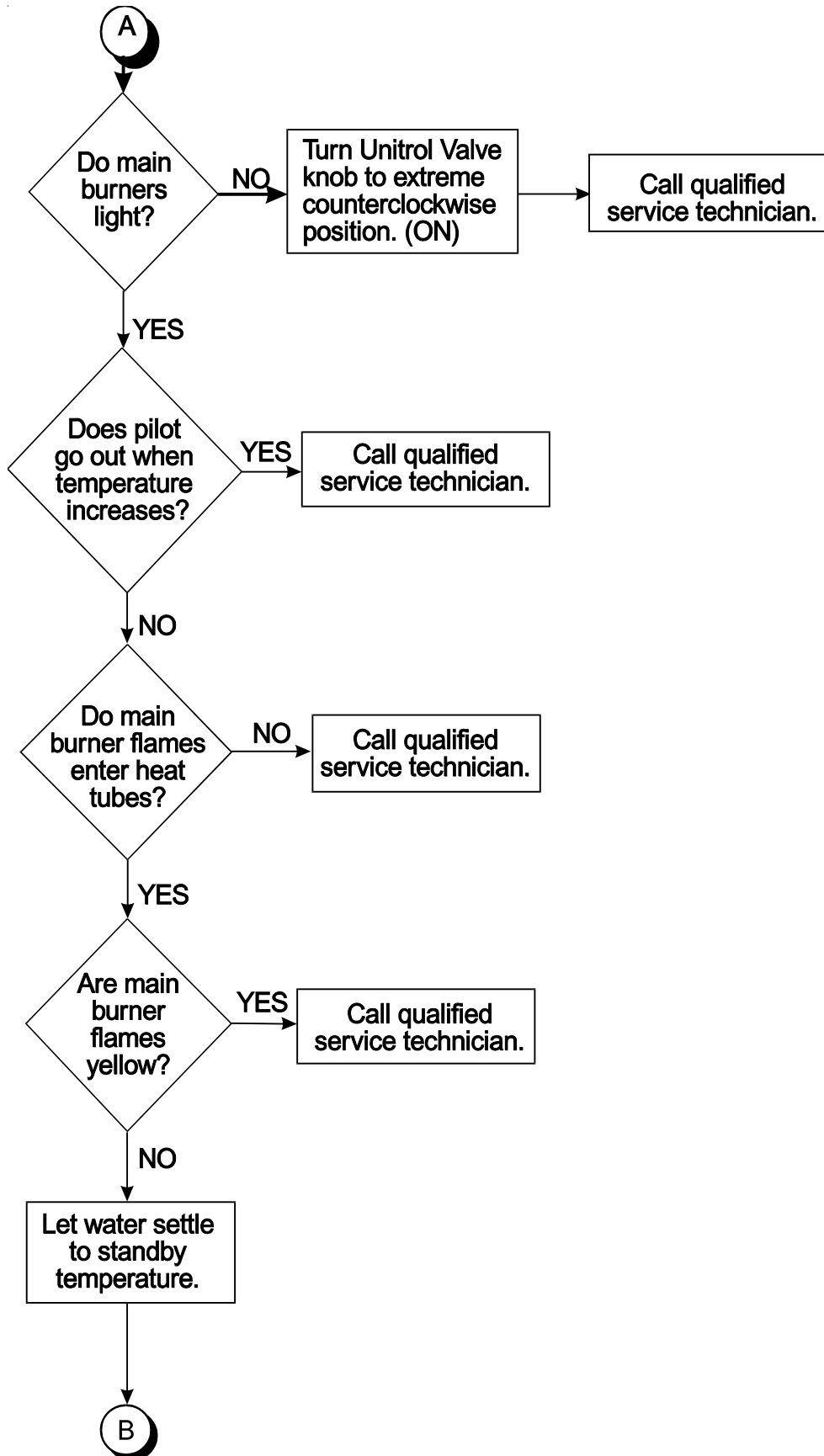

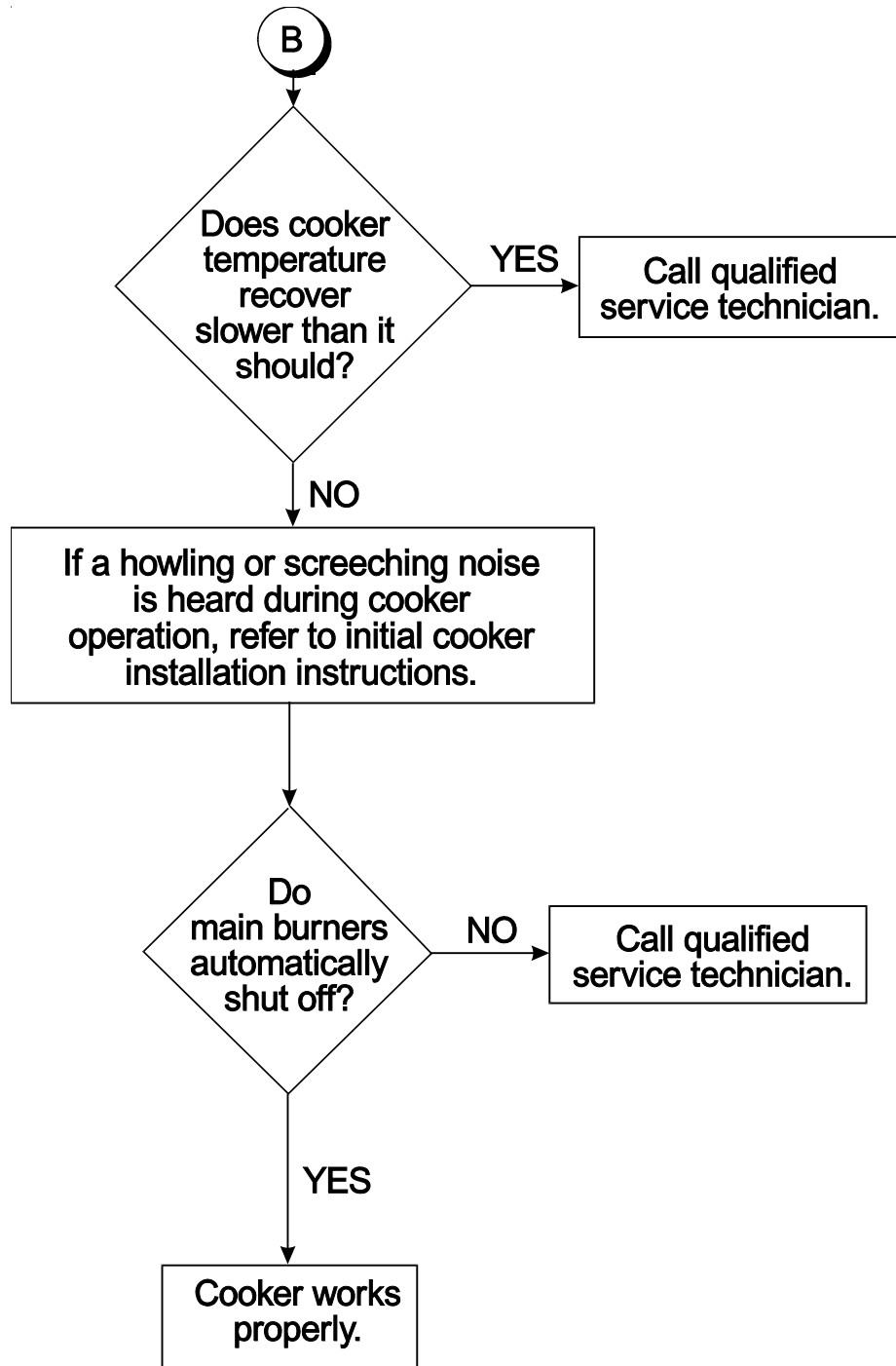

In the event of problems with or questions about you order, please contact the Pitco Frialator factory, from 8:00 a.m. - 5:00 p.m., Eastern Standard Time, Monday through Friday at: (603)225-6684 World Wide

In the event of problems with or questions about you equipment, please contact the Pitco Frialator Authorized Service and Parts representative (ASAP) covering you area, through Pitco Frialator, Inc.



Manuel d'installation, d'utilisation et d'entretien  
pour friteuses à gaz

Modèles  
45C+, 35+C et 40C+

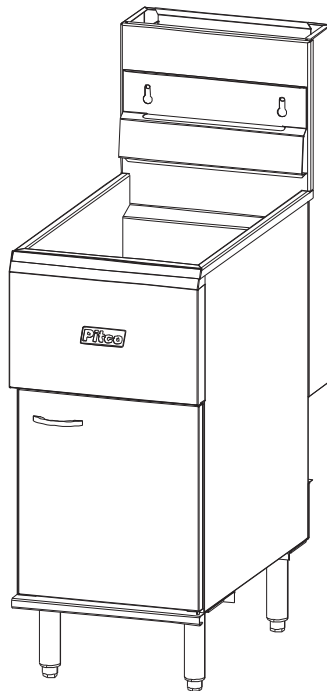

FRANCAIS

# Tables des matières

Section	Titre	Page
	Table des matières.....	i
	Liste des tableaux et figures .....	ii
<b>Chapitre 1: Information d'ordre général et installation .....</b>		<b>1-1</b>
1.1	QUEL EST LE MODÈLE DE VOTRE FRITEUSE? .....	1-1
1.2	VÉRIFICATION DE LA NOUVELLE FRITEUSE .....	1-1
1.2.1	Vérifiez votre commande .....	1-2
1.3	MONTAGE ET MISE À NIVEAU .....	1-2
1.3.1	Installation et réglage des pieds/roulettes .....	1-2
1.3.2	Montage des systèmes à multi-friteuses .....	1-3
1.4	INSTALLATION .....	1-3
1.4.1	Distances de sécurité pour l'installation .....	1-3
1.4.2	Raccordement du gaz .....	1-3
1.4.2.1	Types de carburant .....	1-4
1.4.2.2	Raccordement de la conduite de gaz .....	1-4
1.4.2.3	Raccordement du gaz à déconnexion rapide .....	1-4
1.4.2.4	Fuite de la conduite de gaz et test de pression .....	1-5
1.4.3	Systèmes de ventilation et de protection contre les incendies .....	1-5
1.5	PREMIERS PRÉGLAGES A EFFECTUER .....	1-5
1.5.1	Vérification visuelle .....	1-6
1.5.2	Allumage du brûleur .....	1-6
1.5.2.1	Réglage de la flamme de la veilleuse .....	1-7
1.5.3	Brûleur principal .....	1-8
1.5.3.1	Critères obligatoires pour la conduite du gaz .....	1-8
1.5.3.2	Réglage du brûleur .....	1-8
1.5.4	Nettoyage initial .....	1-9
1.5.5	Vérification de l'étalonnage du thermostat .....	1-10
1.5.6	Étalonnage du thermostat .....	1-11
<b>Chapitre 2: Instructions de fonctionnement .....</b>		<b>2-1</b>
2.1	REEMPLIR LA FRITEUSE .....	2-1
2.1.1	Remplissez la friteuse avec de la matière grasse liquide .....	2-1
2.1.2	Remplissez la friteuse avec de la matière grasse en bloc .....	2-1
2.2	INSTRUCTIONS DE FONCTIONNEMENT .....	2-2
2.2.1	Mise en marche de la friteuse .....	2-2
2.2.2	Faire fondre la matière grasse en bloc .....	2-2
2.2.3	FÉteindre la friteuse .....	2-3
2.3	NETTOYAGE QUOTIDIEN .....	2-3
<b>Chapitre 3: Entretien et réglages à effectuer par le propriétaire .....</b>		<b>3-1</b>
3.1	NETTOYAGE HEBDOMADAIRE (ÉBOUILLANTAGE) .....	3-1
3.2	INSPECTION DU CONDUIT D'ÉVACUATION DE FUMÉE .....	3-1
3.3	GUIDE DE DÉPANNAGE .....	3-2

# Liste des tableaux et figures

<b>Tableau</b>	<b>Titre</b>	<b>Page</b>
1-1	Informations relatives à ce modèle de friteuse .....	1-1
1-2	Références pour la ventilation et les consignes de sécurité incendie .....	1-7

<b>Figure</b>	<b>Titre</b>	<b>Page</b>
1-1	Montage de la veilleuse, Réglage de la flamme .....	1-8
1-2	Valve du gaz indiquant l'emplacement du régulateur de pression et ajusteurs de veilleuse .....	1-9





# Chapitre 1: Information d'ordre général et installation

Félicitations! Vous venez de faire l'acquisition d'une friteuse universelle Pitco Frialator. Cette machine vous offrira des années de fonctionnement fiable si vous suivez les instructions d'utilisation et d'entretien de ce manuel. Vous trouverez dans ce manuel les instructions d'installation, de fonctionnement et d'entretien des friteuses suivantes: modèles 45C+ 35C+ et 40C+.

## 1.1 QUEL EST LE MODÈLE DE VOTRE FRITEUSE?

Il existe deux modèles de friteuses à gaz disponibles. Chaque friteuse possède son propre numéro de modèle. Pour connaître le type de modèle en votre possession, regardez à l'intérieur de la porte au niveau de la plaque signalétique de la machine. Cette plaque comporte des informations pratiques importantes mais pour connaître le modèle, consultez la plaque d'identification du modèle. Le numéro du modèle est celui de la machine. Vous trouverez une brève description de la machine dans la Tableau 1-1.

Tableau 1-1 Informations concernant la friteuse

Numéro de Friteuse	Description	Caractéristiques
45C+	Cette friteuse peut frire jusqu'à 38,5 kg de pommes de terre.	Surface de friture: 35,5 cm x 35,5 cm. Contenance d'huile: 19kg. Puissance en BTU: 122,000.
35C+	Cette friteuse peut frire jusqu'à 28,5 kg de pommes de terre.	Surface de friture: 35,5 cm x 35,5 cm. Contenance d'huile: 15,8kg. Puissance en BTU: 90,000.

FRANCAIS

## 1.2 VÉRIFICATION DE LA NOUVELLE FRITEUSE

Votre nouvelle friteuse a été emballée avec précaution dans une caisse. Tout a été prévu afin que la friteuse vous soit livrée en parfaite condition. Lorsque vous déballez votre nouvelle friteuse, vérifiez toutes les pièces afin de vous assurer qu'elles ne sont pas endommagées. Si une des pièces a été endommagée, veuillez NE PAS signer le connaissance (lettre de transport). Contactez immédiatement le transporteur car ce dernier ne peut être tenu responsable que pendant les 15 jours suivant la livraison. Vérifiez le bordereau d'expédition fourni avec la friteuse afin de vous assurer que vous êtes en possession de toutes les pièces. Si des pièces s'avèrent manquantes, contactez le revendeur auprès duquel vous avez acheté la friteuse.

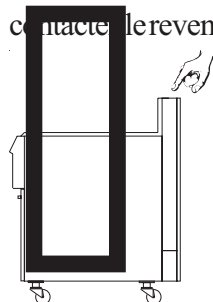

### ATTENTION

Afin d'éviter d'endommager l'appareil, ne pas pencher la friteuse sur deux de ces roues ni tirer sur le conduit de fumée.

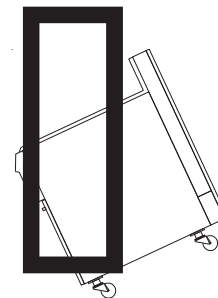

## Chapitre 2: Instructions de fonctionnement

Ce chapitre décrit comment utiliser la friteuse pour un rendement optimal. Vous y trouverez des instructions sur le remplissage, l'utilisation et le nettoyage des friteuses à gaz.

### 2.1 REMPLIR LA FRITEUSE

Vous pouvez utiliser de la matière grasse liquide ou en bloc mais il est préférable d'utiliser de la matière grasse liquide (huile). Pour faire fondre la matière grasse en bloc, suivez attentivement les instructions de la section 2.2.2.

Remplissez jusqu'au repère.

#### 2.1.1 Remplir la friteuse de matière grasse liquide

- Assurez-vous que le robinet de vidange est complètement fermé.
- Remplissez la friteuse d'huile jusqu'au repère du niveau d'huile ("Oil Level") indiqué au dos de la cuve.

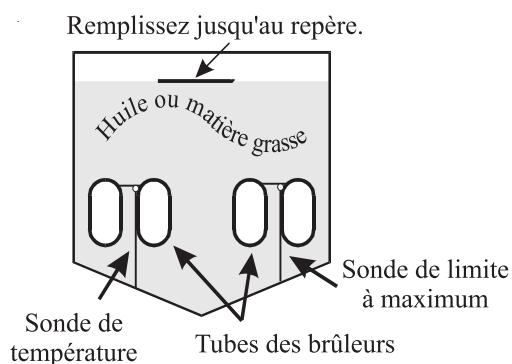

#### 2.1.2 Remplir la friteuse de matière grasse en bloc

### AVERTISSEMENT

Ne jamais faire fondre les blocs de matière grasse directement sur les tubes du brûleur. Ceci provoquera un incendie et annulera la garantie.

- Assurez-vous que le robinet de vidange est complètement fermé.
- Retirez le tamis recouvrant les tubes.
- Coupez la matière grasse en cubes ne dépassant pas 1 po (2,5 cm) de large. Veillez à TOUJOURS placer la matière grasse sous, entre et sur le dessus des tubes des brûleurs. NE PAS laisser de gros espaces d'air. Faites attention à NE PAS plier ni rompre les sondes de température. En effet, si ces dernières sont endommagées, la friteuse ne pourra fonctionner correctement.

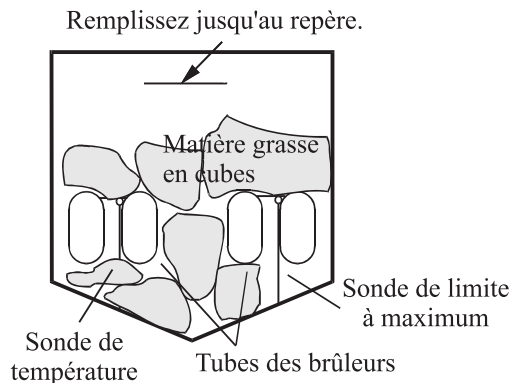

- Après avoir rempli la friteuse de matière grasse, faites fondre la matière grasse. Pour faire fondre la matière grasse, reportez-vous au paragraphe "Mise en marche de la friteuse", section 2.2.1, et au paragraphe "Faire fondre la matière grasse en bloc", section 2.2.2.

## **2.2 INSTRUCTIONS DE FONCTIONNEMENT**

Afin que la nourriture soit toujours parfaitement cuite, suivez les instructions de préparation concernant les aliments que vous comptez frire. Utilisez la meilleure matière grasse possible afin d'obtenir les meilleurs aliments frits. La meilleure matière grasse durera plus longtemps que la matière grasse de qualité inférieure et vous permettra d'économiser de l'argent. Lorsque vous n'utilisez pas la friteuse, laissez refroidir la matière grasse et recouvrez-la afin d'éviter toute contamination.

### **ATTENTION**

La friteuse a été installée en utilisant des dispositifs de retenue et de fixation afin d'éviter qu'elle ne bouge ni se renverse. Ne tentez pas de déplacer la friteuse lorsqu'elle contient un liquide chaud à l'intérieur. Les éclaboussures de liquides chauds risquent de provoquer des brûlures graves.

### **AVERTISSEMENT**

NE PAS mélanger d'eau avec la matière grasse. Conservez tout liquide à l'écart de la matière grasse chaude. Tout aliment surgelé tombant dans la matière grasse chaude entraînera une ébullition intense.

#### **2.2.1 Mise en marche de la friteuse**

##### **NE PAS METTRE EN MARCHE LA FRITEUSE SI ELLE NE CONTIENT PAS D'HUILE!**

- a. Allumez la veilleuse en suivant les instructions de la section 1.5.2.
- b. Tournez le bouton de contrôle de température (thermostat) sur le réglage de température désirée. Ce bouton se trouve derrière les portes avant ou sur le panneau de contrôle avant.
- c. Les brûleurs principaux s'allumeront.

#### **2.2.2 Faire fondre la matière grasse**

### **AVIS**

Il vous faudra allumer et éteindre la friteuse pour faire fondre la matière grasse. Surveillez attentivement la friteuse afin de vous assurer qu'il n'y a pas de fumée. Si vous remarquez de la fumée, la matière grasse est en train de brûler. Afin d'éviter de brûler la matière grasse, réduisez le temps durant lequel les brûleurs sont allumés.

- a. Placez la valve Unitrol sur "ON" (marche).
- b. Réglez le thermostat sur 150°F (65.5°C).
- c. Laissez les brûleurs principaux s'allumer pendant environ quatre (4) secondes.
- d. Baissez le thermostat jusqu'à ce que les brûleurs principaux s'éteignent.

- e. Attendez 30 secondes..
- f. Répétez les étape C à E jusqu'à ce que la matière grasse ait fondue.
- g. Réglez le thermostat sur la température de fonctionnement normale. Les brûleurs demeureront allumés en continu jusqu'à ce que la température de la matière grasse atteigne la température consignée du thermostat.
- h. Une fois la friteuse à sa température de fonctionnement, la friteuse fonctionne normalement et elle est prête à fonctionner.

### 2.2.3 Éteindre la Friteuse:

Il existe deux modes d'arrêt de la friteuse, STANDBY (en attente) et COMPLETE (complet). Le mode d'arrêt en attente empêchera aux brûleurs de s'allumer et de s'éteindre. Le mode d'arrêt complet coupe l'arrivée de gaz à la friteuse. Éteignez la friteuse en:

**STANDBY (en attente)** Réglez le thermostat sur "OFF". Tournez la commande de gaz dans le sens des aiguilles d'une montre jusqu'à "PILOT" (veilleuse). La machine est à présent en mode d'attente et ne pourra demeurer ainsi que pendant une brève période. **NE JAMAIS** laisser la machine demeurer en mode d'attente toute une nuit.



**COMPLETE (complet)** Pour complètement éteindre la machine, appuyez et tournez la commande de gaz dans le sens contraire à celui des aiguilles d'une montre jusqu'à "OFF" (arrêt). La friteuse est à présent complètement éteinte et peut être nettoyée et filtrée.



## 2.3 NETTOYAGE QUOTIDIEN

Nettoyez votre friteuse tous les jours afin qu'elle fonctionne à son rendement optimal et conserve sa belle apparence.

- a. Essuyez toute trace de matière grasse sur l'extérieur de la friteuse. Nettoyez à l'aide d'un chiffon pendant que l'huile est encore chaude.
- b. Utilisez de l'eau chaude et un nettoyant peu puissant pour nettoyer la surface. Veillez à ne pas laisser de l'eau entrer en contact avec l'huile et retirez toute trace de détergent à l'intérieur de la cuve.
- c. Utilisez une poudre à récurer non-abrasive ou un tampon afin de nettoyer toute tâche rebelle.
- d. Procédez au nettoyage par ébullition une fois par semaine comme indiqué ci-dessous.

## Chapitre 3: Entretien et réglages à effectuer par le propriétaire 3-1

Ce chapitre vous offre des informations et des instructions nécessaires afin de procéder à l'entretien de la friteuse et ses réglages. Si après avoir procédé à l'entretien de la friteuse et cette dernière ne fonctionne pas correctement, contactez votre centre de réparation agréé.

### 3.1 NETTOYAGE HEBDOMADAIRE (ÉBOUILLANTAGE)

Cette friteuse doit être complètement nettoyée une fois par semaine. Vidangez complètement la friteuse et procédez à l'ébouillantage de la friteuse avec de l'eau.

- a. Vous aurez besoin d'un contenant suffisamment grand et pouvant contenir 1 1/2 fois l'huile d'une cuve de la friteuse. Ce contenant doit également pouvoir supporter des températures d'eau bouillante.

#### ATTENTION

Éteignez complètement la friteuse lorsque vous comptez remplacer l'huile par de l'eau et lorsque vous avez terminé de chauffer la friteuse. Ceci évitera ainsi que le système de chauffage ne s'allume lors de la vidange de l'huile et du remplissage d'eau.

- b. Vidangez l'huile de la friteuse et jetez-la ou conservez-la afin de la réutiliser plus tard. Retirez les tamis du tube de filtrage et du support ainsi que tout débris de grosse taille demeuré au fond de la cuve. Après avoir nettoyé les tamis du tube de filtrage, replacez-les dans la friteuse. Fermez le robinet de vidange et remplissez la cuve d'eau et de détergent non corrosif. Pour un meilleur résultat, utilisez le nettoyant pour friteuse "Pitco Fryer Cleaner", réf. P6071397.
- c. Allumez à nouveau la friteuse comme il est décrit à la section 2.3 et réglez le thermostat sur 200°F (93.3°C) et amenez lentement l'eau à ébullition. NE PAS laissez l'eau bouillir trop vite car cela provoquera une mousse excessive. Une fois que vous avez amené l'eau à une lente ébullition, éteignez la friteuse.
- d. Laissez la friteuse tremper pendant 20 minutes afin de ramollir les résidus de matière grasse et de carbone. Utilisez une brosse afin de retirer tout résidu demeuré collé à la cuve, aux tubes de chauffage et aux parois latérales. Procédez au nettoyage quotidien décrit à la section 2.6.
- e. Essuyez la cuve avec des chiffons propres jusqu'à ce qu'elle soit complètement sèche. Fermez le robinet de vidange et retirez le contenant.
- f. Reportez-vous à la section 2.1 afin de remplir la friteuse.

### 3.2 INSPECTION DE LA CONDUITE D'ÉVACUATION DE FUMÉE

Il est recommandé de vérifier le conduit d'évacuation de fumée une fois tous les six mois, après que la friteuse ait refroidie. Vérifiez que le conduit ne présente pas de traces de rouille et n'est pas bouché. Assurez-vous que la friteuse est éteinte et veillez ne pas l'allumer pendant la durée de l'inspection. En effet, vous risquez de gravement vous blesser si vous inspectez le conduit d'évacuation de fumée si la friteuse est allumée.

### 3.3 GUIDE DE DÉPANNAGE

Cette section est destinée à vous aider si avez des problèmes avec la friteuse et avec les filtres. Si les mesures correctives ne règlent pas le problème, contactez un réparateur qualifié ou l'usine. Les mesures correctives sont offertes sous forme de diagramme.

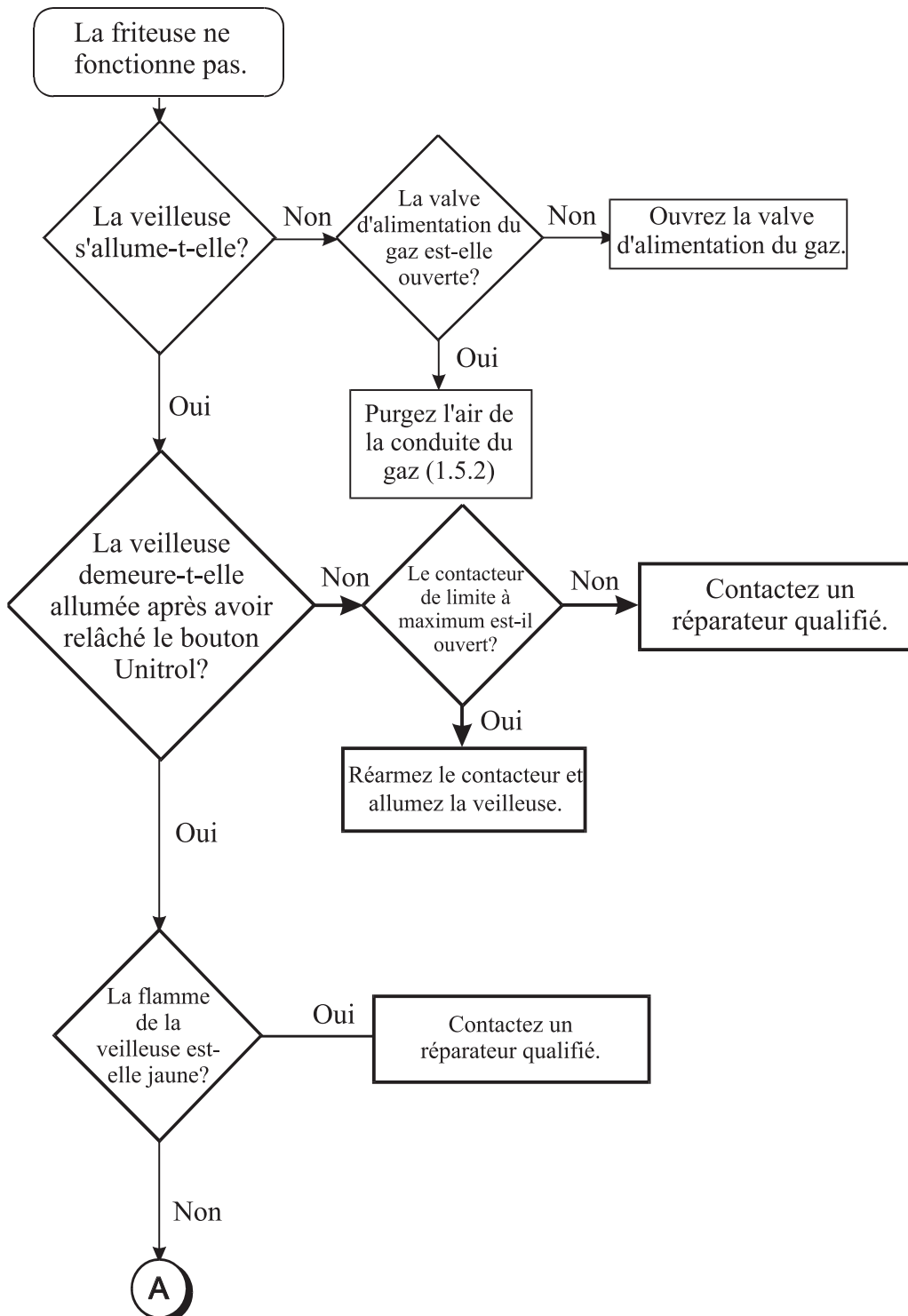

FRANCAIS

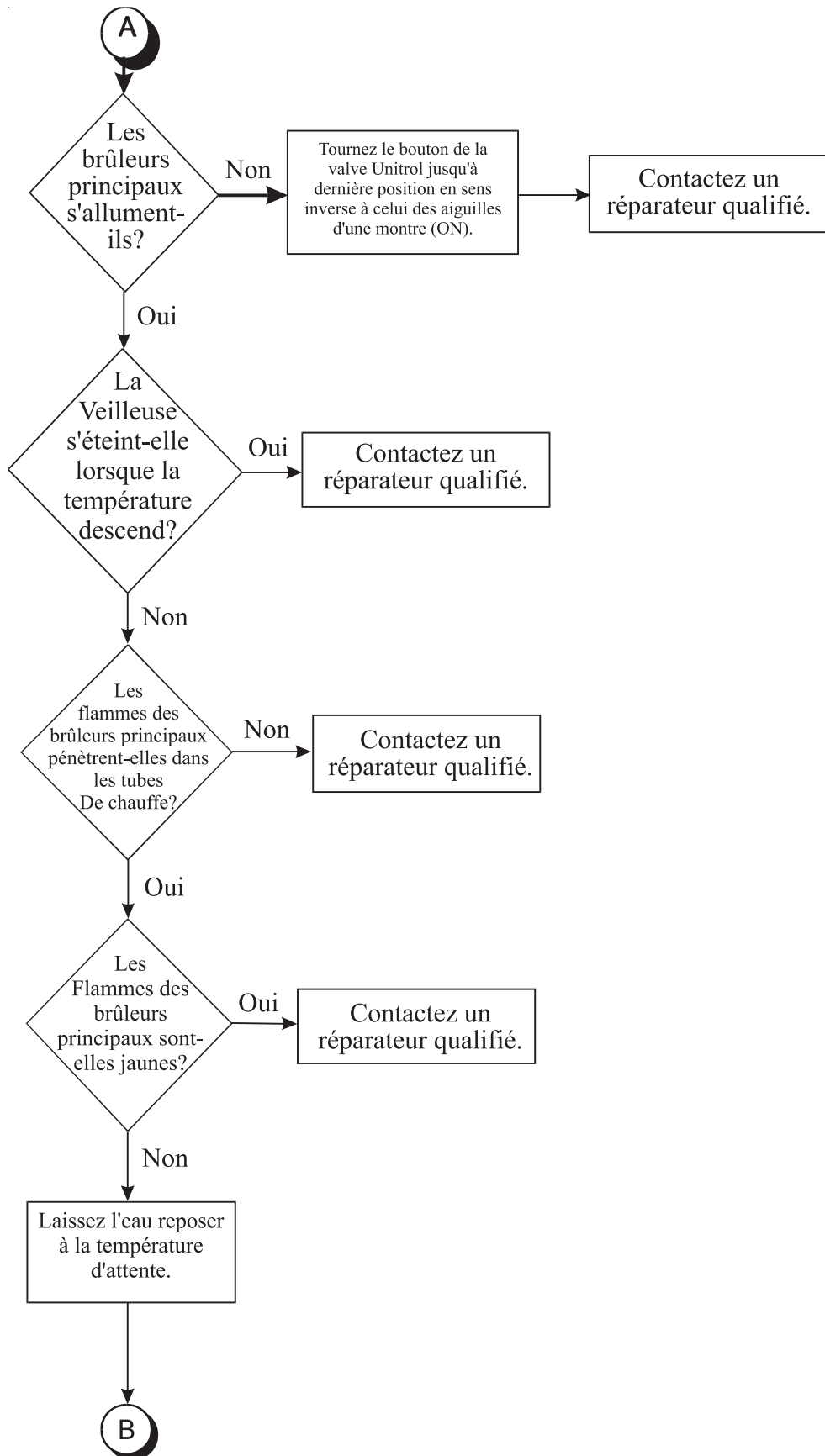

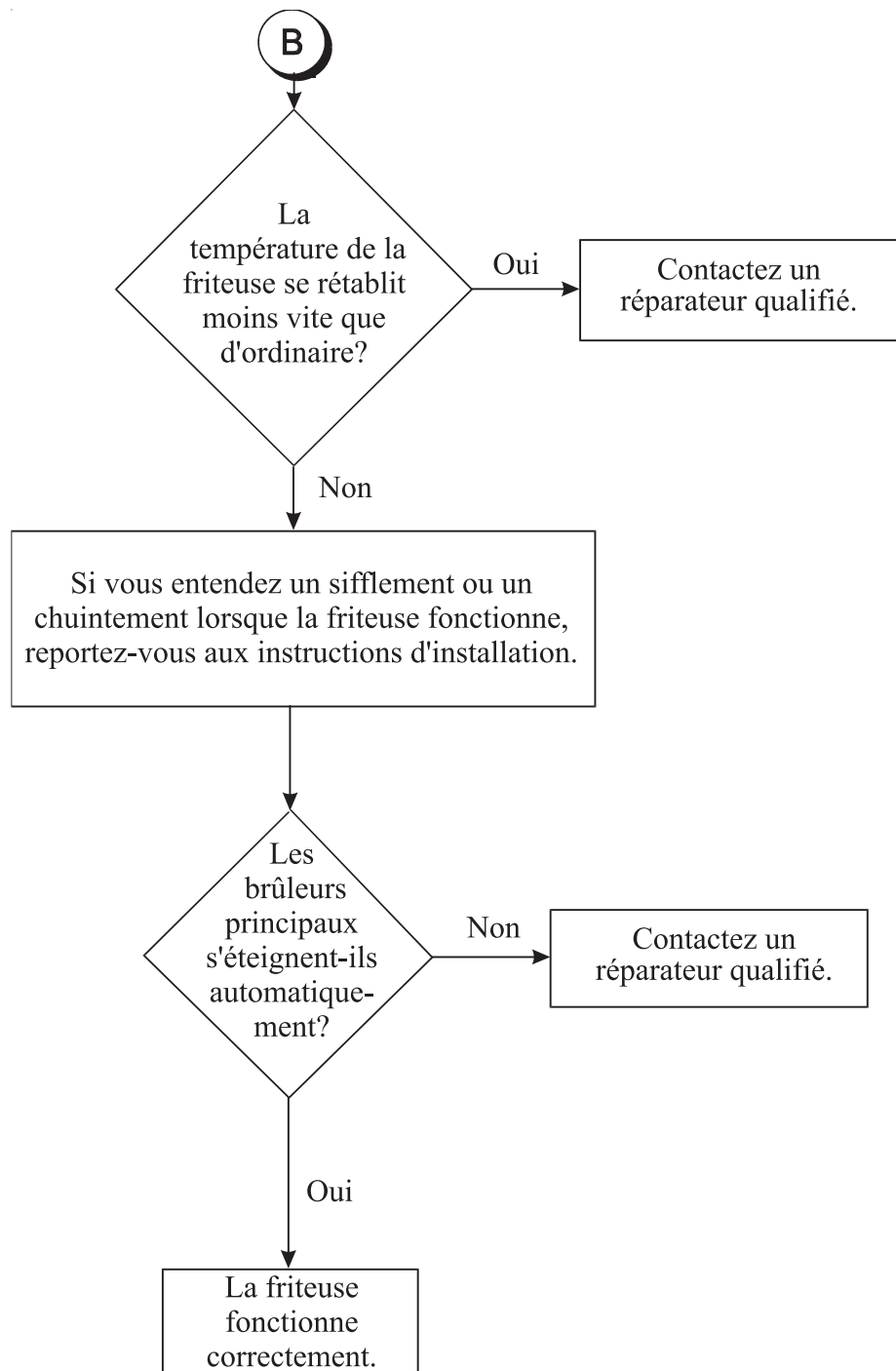



Veillez contacter l'usine Pitco Frialator si vous avez des problèmes ou des questions concernant votre commande de 8:00 heures à 17:00 heures, heure normale de l'Est des États-Unis du lundi au vendredi:  
(603) 225-6684 partout dans le monde

Veillez contacter votre représentant agréé Pitco Frialator si vous avez des problèmes ou des questions concernant votre équipement par l'intermédiaire du réseau de service après-vente national au: