

## Meat Slicer

### Model: HBS-220JS



- *Classic meat slicer with plastic legs and handle. Its anodized aluminum-magnesium alloy body ensures food-contact parts are safe and easy to clean.*
- *The razor sharp 9 inch stainless steel blade, featuring an adjustable thickness knob, cuts slices up to 1/2 inch thick and is rated for 2 hours of use daily.*
- *The easy to use built-in sharpener ensures your blade stays like new, and the manual feed carriage glides smoothly for easy operation and is removable for cleaning.*

**Toll Free: +1 (800) 373-8699**  
**Info@chefmindgroup.com**  
Address: 1189S Jellick Ave,  
City of Industry, CA 91748



## Meat Slicer

### Model: HBS-220JS

**•ETL Certified For Safety & Sanitation**

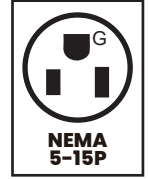

MODEL	VOLTS	HERTZ	PHASE	POWER	BLADE SIZE	NEMA PLUG	NET WEIGHT	GROSS WEIGHT	SHIPPING DIMENSIONS
HBS-220JS	110V	60Hz	1PH	120W	9"	5-15P	27 lbs	31 lbs	20 1/2" x 16 1/2" x 15"

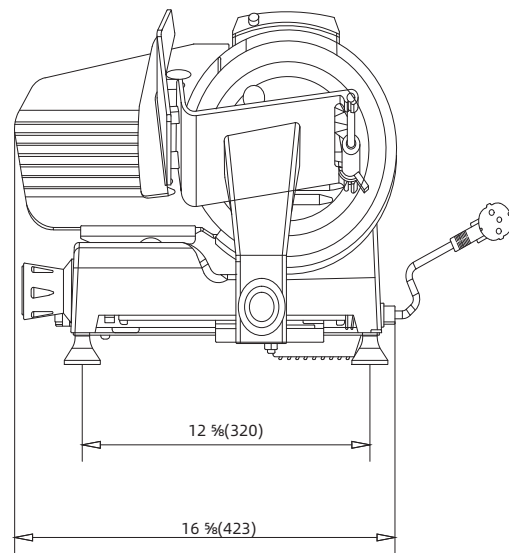
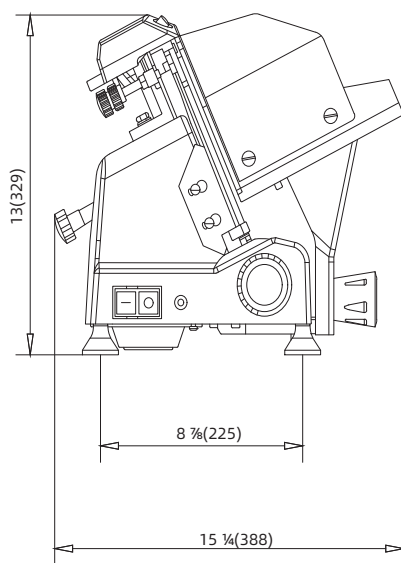

**1 YEAR PARTS WARRANTY (NOT FOR RESIDENTIAL USE)**

