

72" Refrigerated Bakery Display Case

Model: PLM-571A



- Tested to NSF Standard 7 requirements for open food storage.
- Sliding Door Design, The design of sliding doors can greatly save space for your store or restaurant.
- Adjustable 3 Glass Shelves, you can adjust in height depending on what you want to display.
- Digital Temperature Control, Our display case uses R290 refrigerant, which keeps the interior temperature at a safe level between 32°F-53.6°F.
- Brilliant Internal LED lighting each shelf and bottom.
- Digital temperature control and display.
- Ventilated cooling system.
- Automatic Defrost.
- Front flat glass.
- Options Air duct outside the glass to remove condensation water.
- Easy to mount casters (3 lockable) are standard with all units.

72" Refrigerated Bakery Display Case

Model: PLM-571A

•ETL Certified For Safety & Sanitation



MODEL	EXTERNAL DIMENSION (inches)	V/Hz/Ph	STORAGE CAPACITY L	DOORS	TEMPERATURE	REFRIGERANT	AMPS	SHELVES	NEMA PLUG	SHIPPING WEIGHT (lbs.)
PLM-571A	71 3/8 x 26 7/8 x 55 1/2	115/60/1	650	4	32°F to 53.6°F	R290	7.7	3	5-15P	618

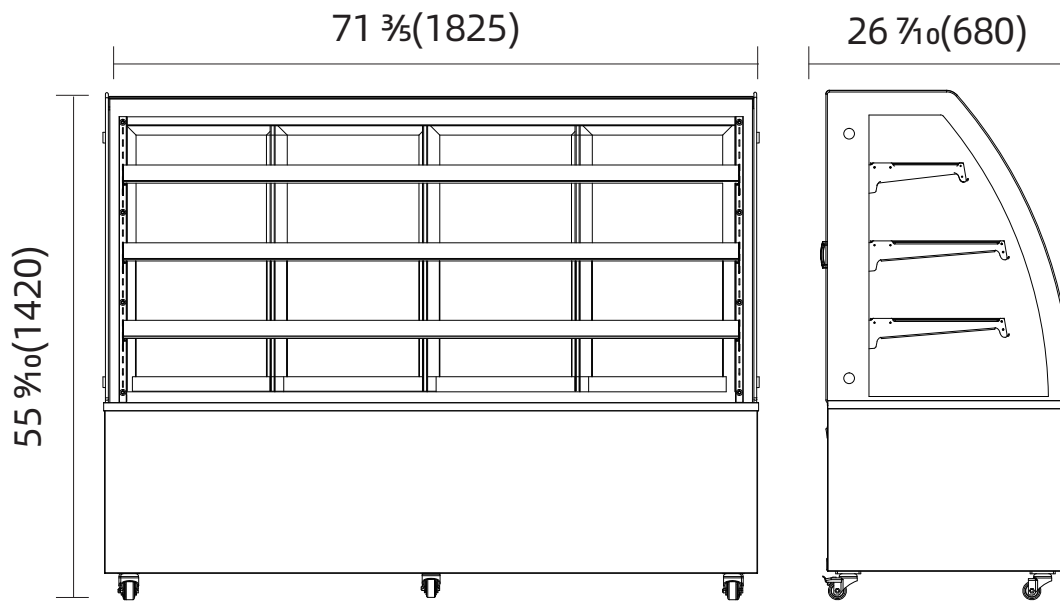

1 YEAR PARTS WARRANTY (NOT FOR RESIDENTIAL USE)



CHEFMIND GROUP INC.

SPECIFICATIONS SUBJECT TO CHANGE WITHOUT NOTICE