

53" Countertop Refrigerated Sushi Display Case

Model: PLM-R52L



- Tested to NSF Standard 7 requirements for open food storage.
- Brilliant internal LED illumination on top.
- Our display case uses R-290 refrigerant, which keeps the interior temperature at a safe level between 32°F-53.6°F.
- The design of sliding doors can greatly save space.
- A drain is located in the back of the unit to re-route water collected by the automatic defrost system.
- Front Curved glass Sliding doors.
- Direct cooling system.
- Automatic defrost.
- Top evaporator with basin to collect condensation.
- GN pan can be ordered.
- Light box for advertisement.

53" Countertop Refrigerated Sushi Display Case

Model: PLM-R52L

•ETL Certified For Safety & Sanitation



MODEL	EXTERNAL DIMENSION (inches)	V/Hz/Ph	CAPACITY-GROSS	NET WEIGHT (lbs.)	TEMPERATURE	REFRIGERANT	AMPS	DOORS	NEMA PLUG	SHIPPING WEIGHT (lbs.)
PLM-R52L	53 1/8 x 16 1/2 x 10 3/8	115/60/1	5*1/3 GN	84.9	32°F to 53.6°F	R290	1.3	2	5-15P	90

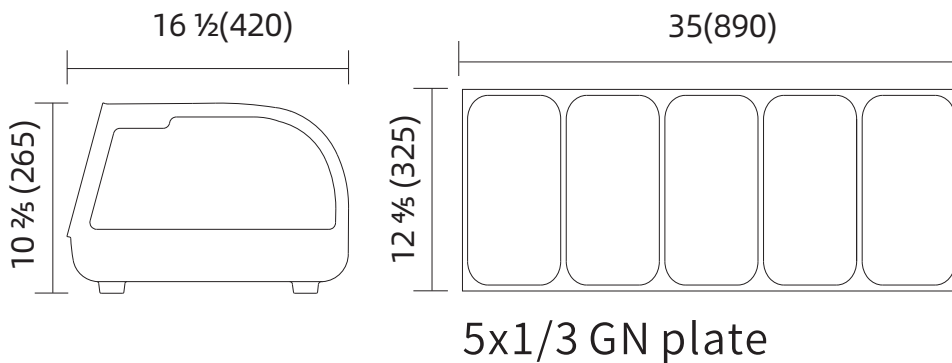

1 YEAR PARTS WARRANTY (NOT FOR RESIDENTIAL USE)

