

# 18" 4-Sided Glass Refrigerated Display Case

## Model: PLM-R68L-3



- Tested to NSF Standard 7 requirements for open food storage.
- Internal Top LED light.
- Digital Temperature Control.
- Display case uses R-290 refrigerant, which keeps the interior temperature at a safe level between 32°F-53.6°F.
- Adjustable PVC coated shelves.
- 4 sides double glass.
- Maintenance free condenser.
- Ventilated cooling system.
- Automatic defrost.
- Air duct outside the glass to remove condensation water.
- Lockable Door.
- Brilliant Internal LED illumination on sides.

# 18" 4-Sided Glass Refrigerated Display Case

## Model: PLM-R68L-3

**•ETL Certified For Safety & Sanitation**



MODEL	EXTERNAL DIMENSION (inches)	V/Hz/Ph	STORAGE CAPACITY L	NET WEIGHT (lbs.)	TEMPERATURE	REFRIGERANT	AMPS	DOORS	NEMA PLUG	SHIPPING WEIGHT (lbs.)
PLM-R68L-3	17 7/8 x 16 x 35 1/10	115/60/1	68	77.2	32°F to 53.6°F	R290	2	1	5-15P	82

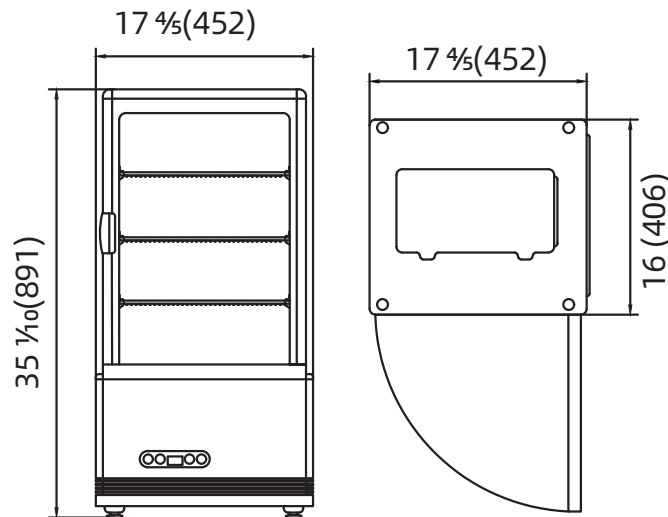

**1 YEAR PARTS WARRANTY (NOT FOR RESIDENTIAL USE)**



**CHEFMIND GROUP INC.**

SPECIFICATIONS SUBJECT TO CHANGE WITHOUT NOTICE